

# Shanghai IUGIS Carbon Industry Co.,Ltd

Email:summer@iugiscarbon.com

Skype:summer@iugiscarbon.com

## washing machine carbon brushes

5 × 12.5 × 36MM



WS1---5-12.5-36mm

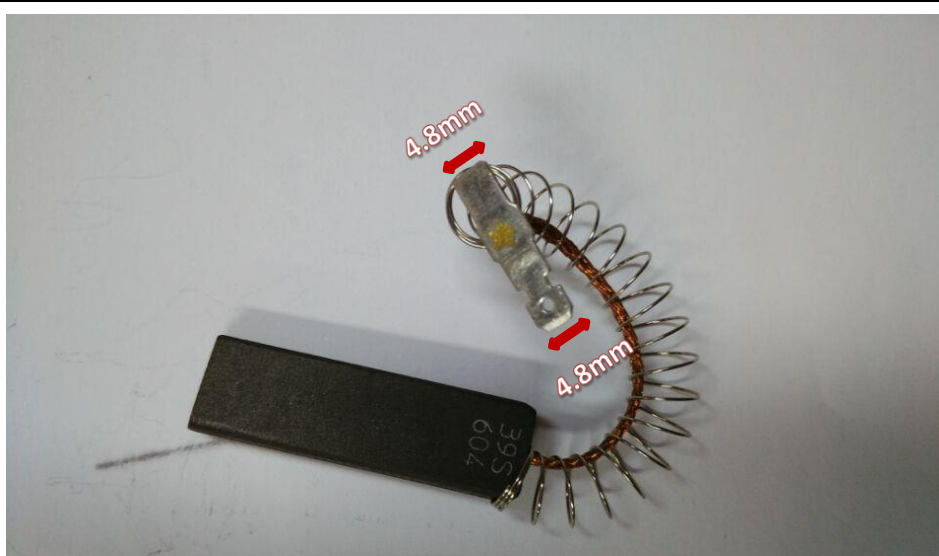

WS2 -- 5\*12.5\*41.5mm



<b>WS3</b>	5-15-30mm
	5.6mm terminal



<b>WS4</b>	5-13-40mm
	4.8mm terminal



<b>WS4-A</b>	5-13-40mm
	4.8mm terminal



<b>WS5</b>	5-13.5-40mm
	4.8mm terminal



<b>WS5-A</b>	5-13.5-40mm
	4.8mm terminal



<b>WS6</b>	5-12.5-36mm
	4.8mm terminal



<b>WS6-A</b>	5-12.5-36mm
	4.8mm terminal

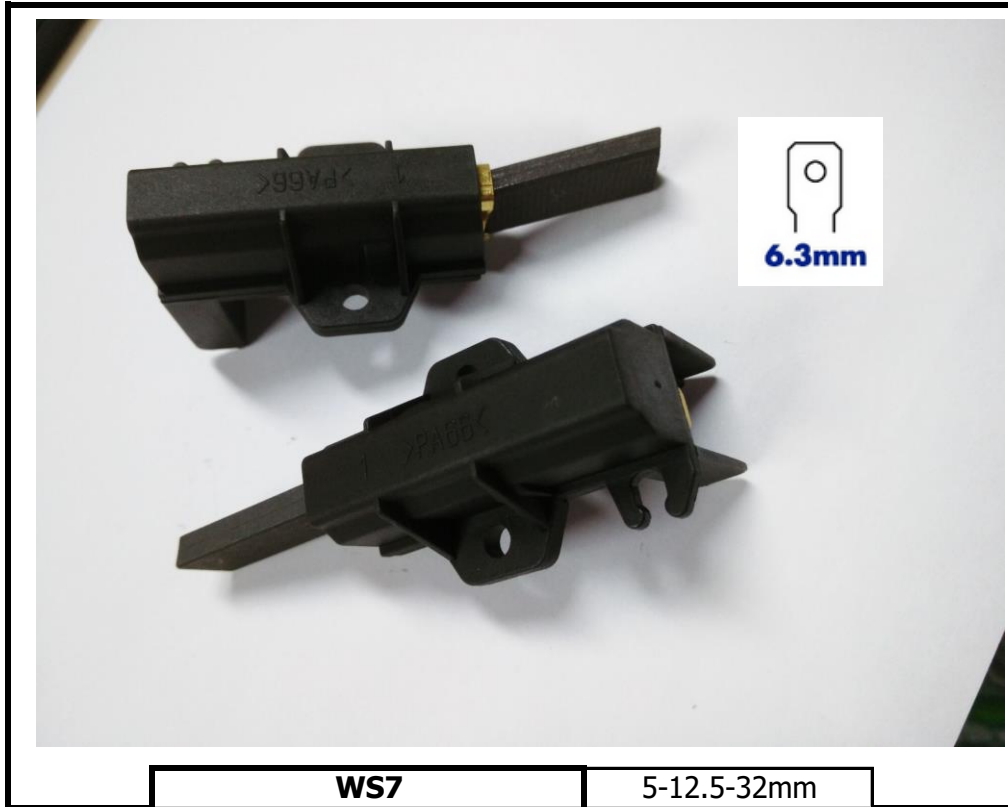

<b>WS7</b>	5-12.5-32mm
	6.3mm terminal



<b>WS7-A</b> (black holder)	5-12.5-32mm
	6.3mm terminal



<b>WS8</b>	5-13.5-40mm
	4.8mm terminal

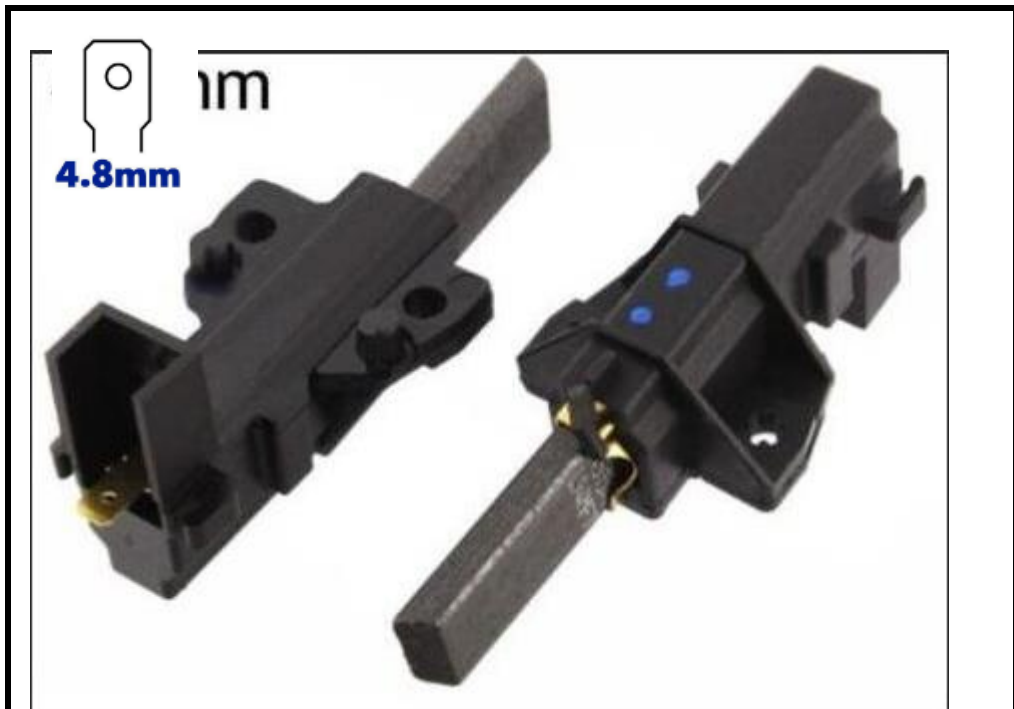

<b>WS8-A</b>	5-13.5-40mm
	4.8mm terminal



6.3mm



<b>WS9</b>	5-12.5-32mm
	6.3mm terminal



6.3mm



<b>WS9-A</b>	5-12.5-32mm
	6.3mm terminal





<b>WS10</b>	5-12.5-36mm
	4.8mm terminal



<b>WS10-A</b>	5-12.5-36mm
	4.8mm terminal

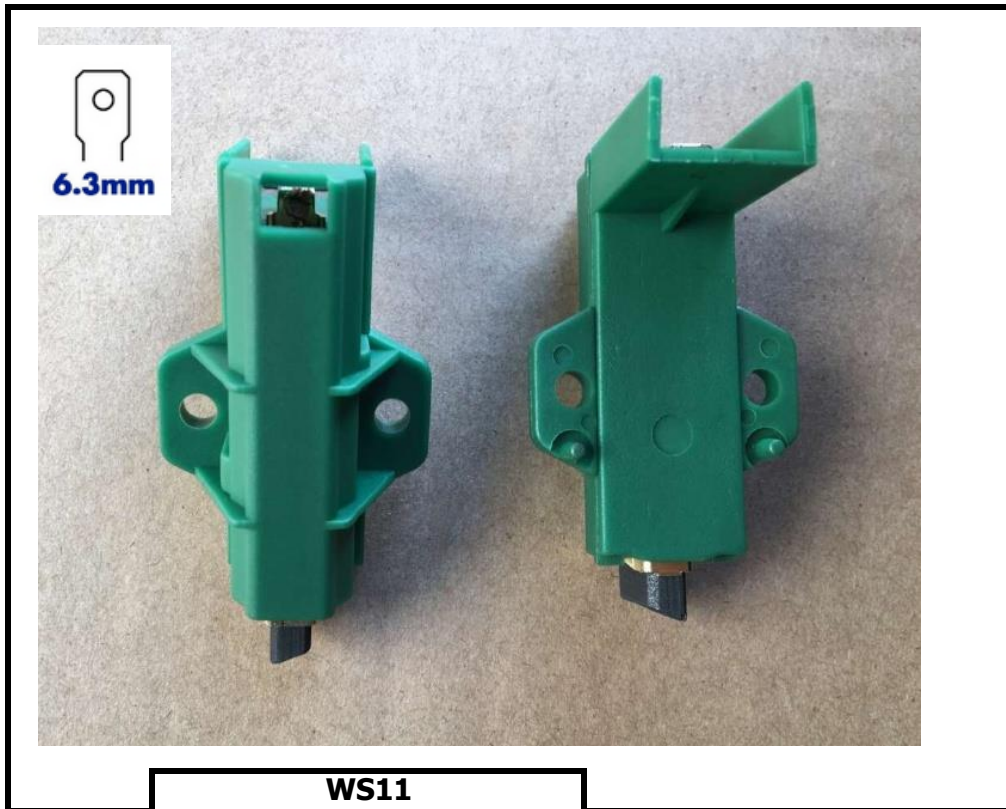

**WS1**  
5-12.5-36 / 5-12.5-32mm

6.3mm terminal

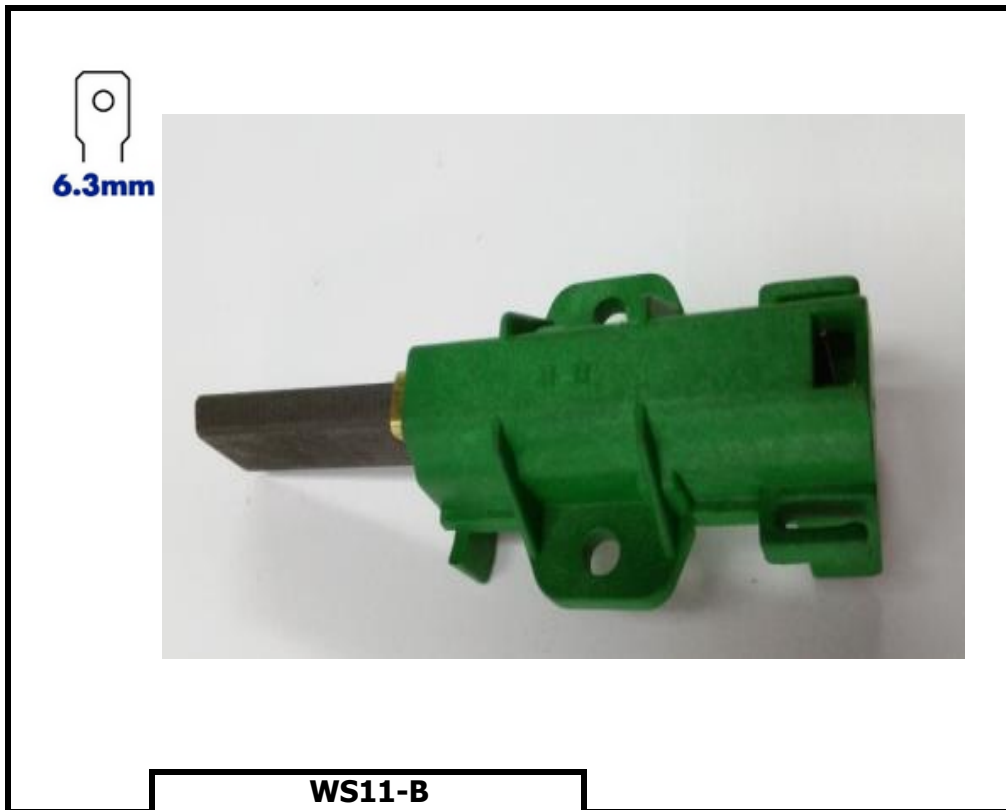

**WS11-B**  
5-12.5-36mm

6.3mm terminal

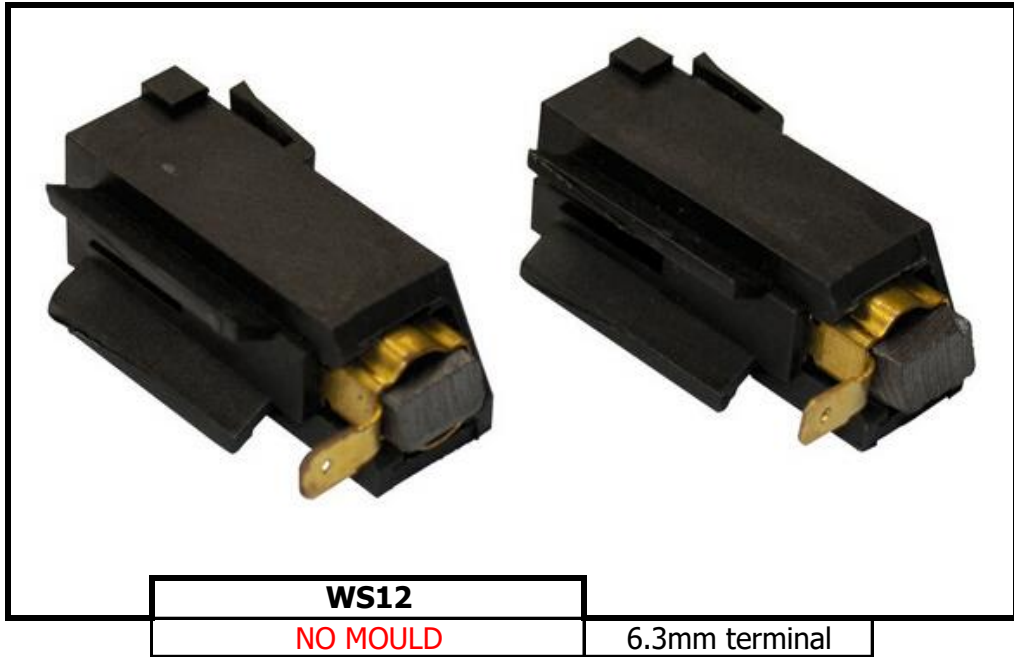



<b>WS14</b>
NO MOULD



<b>WS15</b>	5*13.5*40mm
	6.3mm terminal



6.3mm

<b>WS15-A</b>	5*13.5*40mm
	6.3mm terminal



4.8mm

<b>WS16</b>	5*12.5*41.5mm
	4.8mm terminal



**WS16-A 5\*12.5\*41.5mm**

4.8mm terminal



**WS17 5\*13.5\*40mm**

4.8mm terminal



<b>WS17-A</b>	<b>5*13.5*40mm</b>
---------------	--------------------

4.8mm terminal
----------------



<b>WS18</b>
<b>5*12.5*32 mm</b>

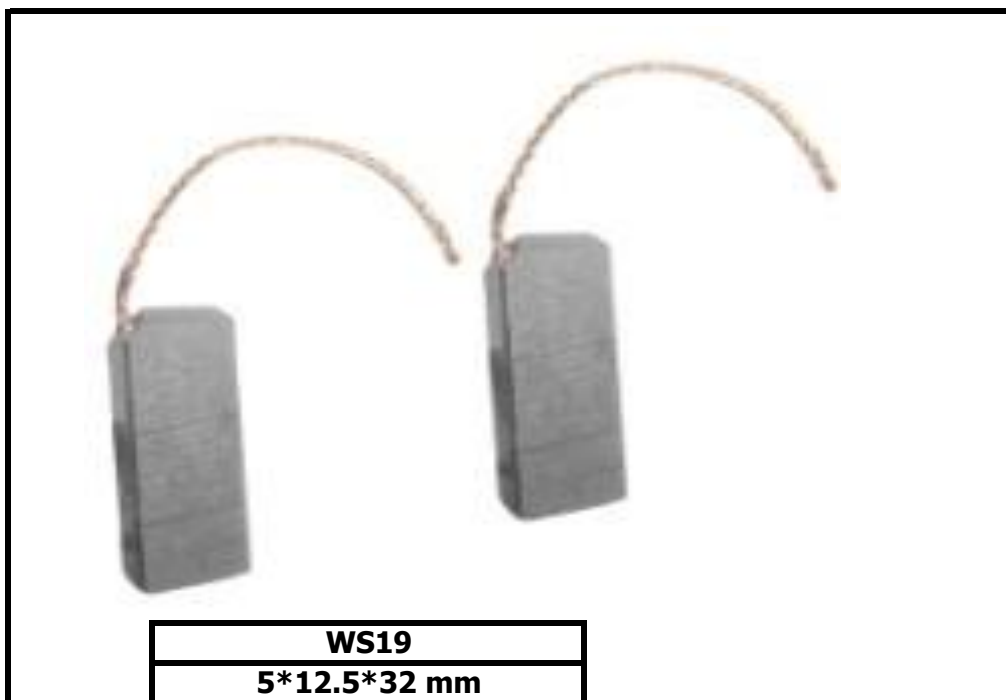

<b>WS19</b>
<b>5*12.5*32 mm</b>



<b>WS20</b>
<b>5*12.5*36 mm</b>





<b>WS21</b>
<b>5*13.5*40 mm</b>



<b>WS22</b>
<b>5*15*30 mm</b>

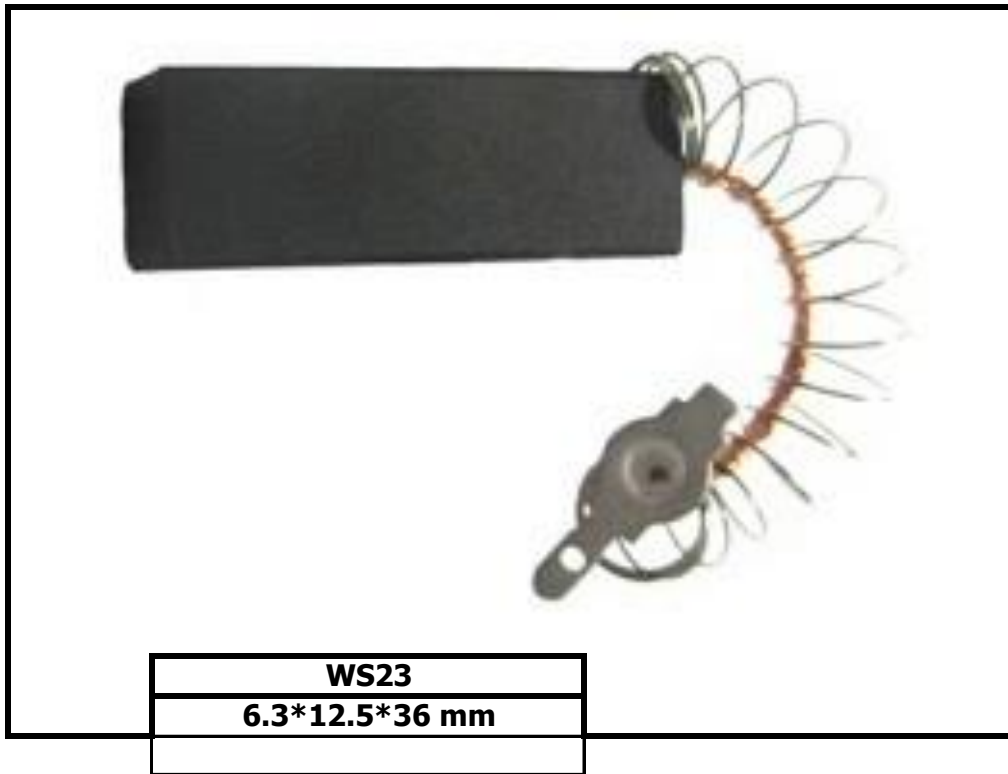



**WS25**

5-12.5-32mm



**WS25-A**

5-12.5-32mm





**WS27**

5-13.5-40mm



**WS27-A**

5-13.5-40mm



**WS28**

thickness : **4mm**



**WS28-A**

thickness : **5mm**

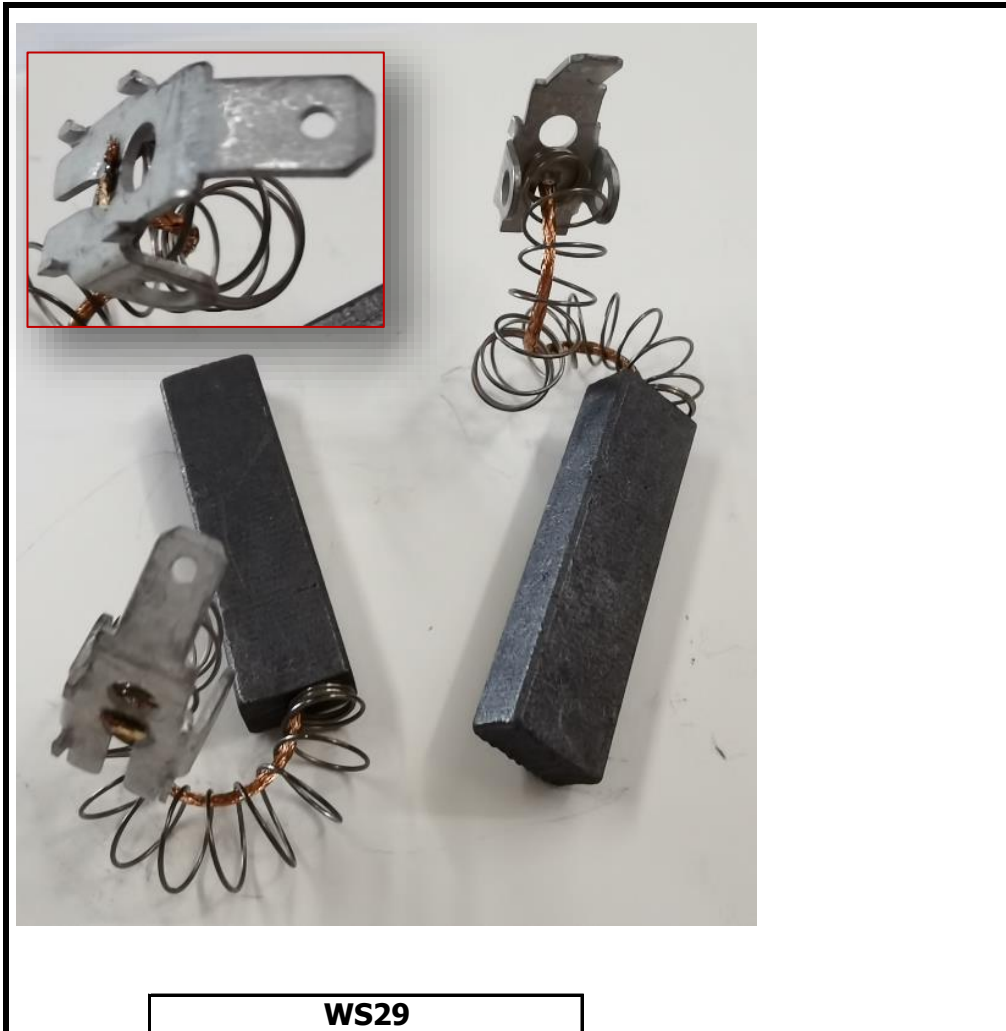

**WS29**  
6.2-10-36mm